

coemar

CF 7 Wash Zoom

**manuale
di istruzioni
instruction
manual**

**1[^] edizione, novembre 2000
1st edition, november 2000**

CF 7 Wash Zoom

numero di serie/serial number

data di acquisto/date of purchase

fornitore/retailer

indirizzo/address

cap/città/suburb

provincia/capital city

stato/state

tel./fax/

*Prendete nota, nello spazio apposito, dei dati relativi al modello e al rivenditore del vostro **CF 7 Wash Zoom**: in caso di richiesta di informazioni, pezzi di ricambio, servizi di riparazione o altro ci permetteranno di assistervi con la massima rapidità e precisione.*

*Please note in the space provided above the relative service information of the model and the retailer from whom you purchased your **CF 7 Wash Zoom**: This information will assist us in providing spare parts, repairs or in answering any technical enquiries with the utmost speed and accuracy.*

ATTENZIONE: la sicurezza dell'apparecchio è garantita solo con l'uso appropriato delle presenti istruzioni, pertanto è necessario conservarle.

WARNING: the security of the fixture is granted only if these instructions are strictly followed; therefore it is absolutely necessary to keep this manual.

Index

1. Packaging	Pag. 27
2. Transportation	.. 27
3. Important safety information	.. 28
4. Lamp: installation and replacement	.. 29
5. Operating frequency and voltage	.. 31
6. Installation	.. 32
7. Mains connection	.. 33
8. Signal connection	.. 34
8.1 signal connection using an XLR 5 plug/socket	.. 34
8.2. signal connection using an XLR 3 plug/socket	.. 35
9. Powering up	.. 36
10. DMX addressing	.. 37
11. Display panel functions	.. 38
11.1 Powering up the CF 7 Wash Zoom without articulated movement	.. 39
11.2 Counter reset	.. 39
11.3 Test	.. 39
12. DMX 512 signal functions	.. 40
13. Aligning the lamp in the optical system	.. 41
14. Opening up the projector housing	.. 42
15. Interchanging dichroic filters on the colour wheel	.. 43
16. Automatic internal functions	.. 44
17. Maintenance	.. 45
18. Electronic motor alignment	.. 46
19. Spare parts	.. 47

Authorised coemar service centres worldwide

Congratulations on having purchased a **coemar** product. You have assured yourself of a fixture of the highest quality, both in componentry and in the technology used. We renew our invitation to you to complete the service information on the previous page, to expedite any request for service information or spares (in case of problems encountered either during, or subsequent to, installation). This information will assist in providing prompt and accurate advice from your **coemar** service centre.

1. Packaging

Following the instructions and procedures outlined in this manual will ensure the maximum efficiency of this product for years to come.

Open the packaging and ensure that no part of the equipment has suffered damage in transit. In case of damage to the equipment, contact your carrier immediately by telephone or fax, following this with formal notification in writing.

packing list

Ensure the packaging contains:

1 **CF 7 Wash Zoom**

1 **instruction manual**

2. Transportation

The **CF 7 Wash Zoom** should be transported in its original packaging or in a **coemar approved flight case**.

In order to manufacture a suitable flight case, we recommend the following simple procedure be followed, which will stop the articulated movement of the **CF 7 Wash Zoom** during transportation.

The following diagram illustrates coemar's recommended construction of the internal for a roadcase to suit this fixture.

A) Padding around the entire projector, including the base, with suitable padding materials.

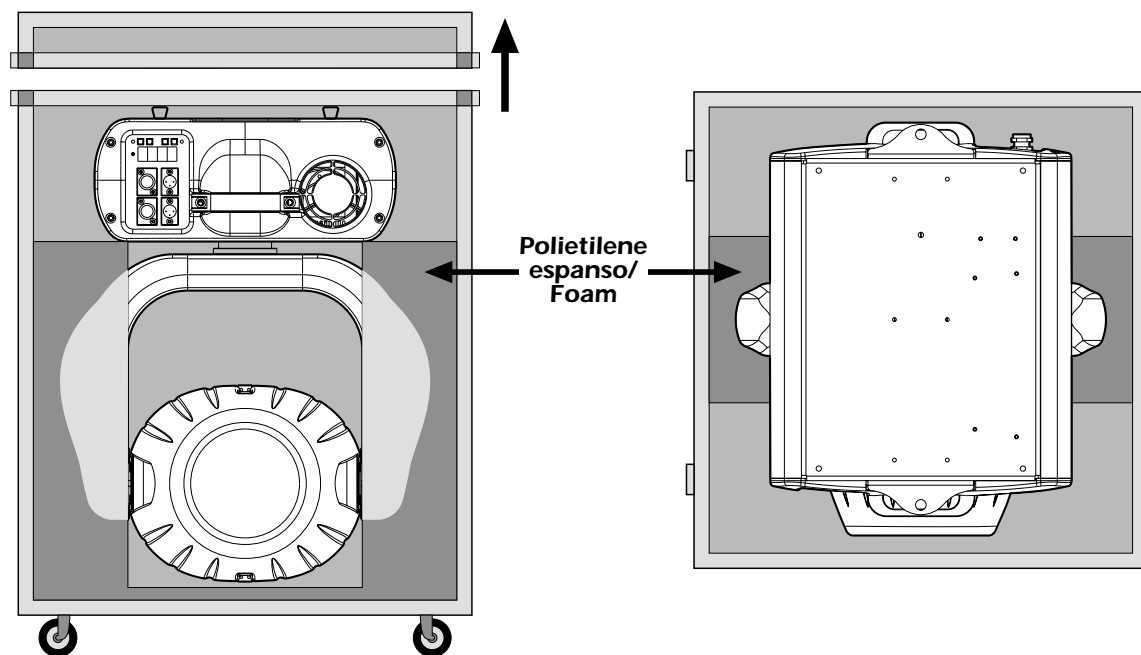

3. Important safety information

Fire prevention:

1. **CF 7 Wash Zoom** utilises a Philips MSR 700 SA; the use of any alternative lamp is not recommended and will null and void the fixture's warranty.
2. Never locate the fixture on any flammable surface.
3. Minimum distance from flammable materials: 0,5 m.
4. Minimum distance from the closest illuminable surface: 2 m.
5. Replace any blown or damaged fuses only with those of identical values. Refer to the schematic diagram if there is any doubt.
6. Connect the projector to mains power via a thermal magnetic circuit breaker.

Prevention of electric shock:

1. High voltage is present in the internals of the unit. Isolate the projector from mains supply prior to performing any function which involves touching the internals of the unit, including lamp replacement.
2. For mains connection, adhere strictly to the guidelines outlined in section 7 of this manual.
3. The level of technology inherent in the **CF 7 Wash Zoom**, requires the use of specialised personnel for all service applications; refer all work to your authorised **coemar** service centre.
4. A good earth connection is essential for proper functioning of the projector. Never operate the unit without proper earth connection.
5. The fixture should never be located in an exposed position, or in areas of extreme humidity. A steady supply of circulating air is essential.

Protection against ultraviolet radiation:

1. Never turn on the lamp if any of the lenses, filters, or the carbon fibre housing is damaged; their respective functions will only operate efficiently if they are in perfect working order.
Never look directly into the lamp when it is operating.

Safety:

1. The projector should always be installed with bolts, clamps, and other fixings which are suitably rated to support the weight of the unit.
2. Always use a secondary safety chain of a suitable rating to sustain the weight of the unit in case of the failure of the primary fixing point.
3. The external surface of the unit, at various points, may exceed 150°C. Never handle the unit until at least 10 minutes have elapsed since the lamp was turned off.
4. Always replace the lamp if any physical damage is evident.
5. Never install the fixture in an enclosed area lacking sufficient air flow; the ambient temperature should not exceed 35°C.
6. A hot lamp may explode. always wait for at least 10 minutes to elapse after the unit has been turned off prior to attempting to replace the lamp.
Always wear suitable hand protection when handling the lamp.

4. Lamp: installation and replacement

CF 7 Wash Zoom utilises a Philips MSR 700/SA lamp of 700W with a GY 9,5 lamp base. The lamp is available from your authorised coemar sales agent.

coemar cod.	105090/1
wattage	700 w
luminous flux	45.000 lm
colour temperature	5550° K
base	GY 9,5
approximate life	500 hours

Attention

Turn off the power prior to opening up the unit.

The fixture's internal temperature can reach 250° C after 5 minutes, with a maximum peak of 350° C; ensure that the lamp is cold prior to attempting removal. The fixture should be allowed to stand and cool for 10 minutes prior to its removal. MSR/SA lamps are part of the mercury vapour family of discharge lamps and must be handled with great care. The lamp operates at high pressure, and the slight risk of explosion of the lamp exists if operated over its recommended life of 500 hours. We recommend, therefore, that the lamp be replaced within the manufacturer's specified lamp life.

installing the lamp

- 1) Using a Phillips head screwdriver, remove the screws (A) which hold the lampholder in place, located at the rear of the projector head.



- 2) Remove the lampholder assembly (B).

- 3) Locate the lampholder (C)



- 4) Insert the lamp. The lamp used is manufactured from quartz glass and should be handled with care; always adhere to the instructions supplied in the lamp's packaging. Never touch the glass directly, use the tissue provided in the lamp's packaging. The GY 9,5 lampbase is assymetrical in construction, with one lamp pin socket larger than the other; make sure therefore that the correct pin is lined up into its respective pin socket. **DO NOT USE UNDUE FORCE.** In case of difficulty, re-read the instructions and repeat the procedure.



English

5) Replace the lamp assembly (**B**) and replace and tighten the screws (**A**) which were previously removed.



Attention: we recommend that the lamp be realigned in the optical train of the unit to avoid overheating of the dichroic filters and other internal components of the unit. refer to section 13 for instructions about this procedure.

5. Operating voltage and frequency

The projector may operate at voltages including 208, 230 or 240 V. **coemar** presets (barring specific requests) a voltage of 240v.

The preset voltage is indicated on a sticker located on the base of the projector near the position of the voltage selector switch.

CF 7 Wash Zoom may operate at either 50 or 60 Hz without any changes required.

selecting an operating voltage different to the factory preset

It is possible to alter the operating voltage of the projector at any time, by using the selector located on the base of the projector.

The selector allows you to choose from 2 preset voltages indicated on the sticker located adjacent to the switch.

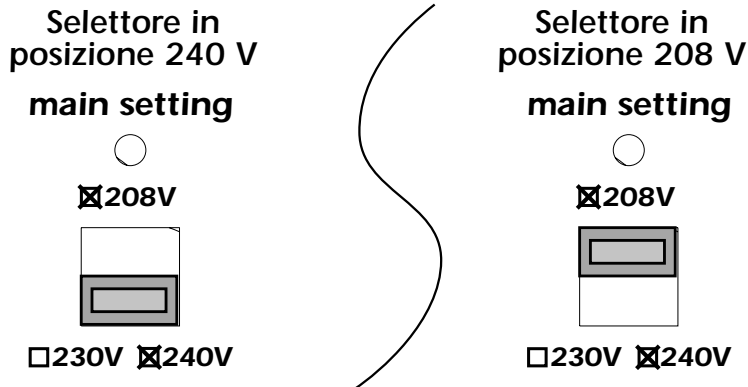

Select the required voltage by simply sliding the switch to the correct position.

Should you wish to operate the projector at a voltage other than those indicated on the selector switch, contact your authorised **coemar** service centre, or consult the projector's circuit diagrams. This procedure should only be carried out by qualified service personnel.

6. Installation

mounting

CF 7 Wash Zoom may be either floor or ceiling mounted.



For floor mounted installations **CF 7 Wash Zoom** is provided with four rubber mounting feet. These feet may be removed if required for permanent installations or suchlike.



For ceiling mounted installations remove the rubber feet and use appropriate clamps or fixings to attach the fixture to the mounting surface. The structure from which the unit is hung should be of sufficient rating to hold the weight of the unit, as should any clamps used to hang the unit.

The structure should also be sufficiently rigid so as not to move or shake whilst the **CF 7 Wash Zoom** moves during operation.

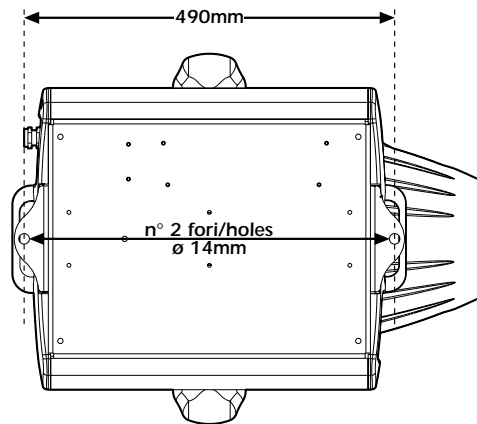

protection against liquids

The projector contains electric and electronic components that must not come into contact with water, oil, or any other liquid.

movement

The projector has a movement of 630° in the base and 260° in the yoke; **DO NOT** place any obstructions in the path of the projector's movement.

safety chain

The use of a safety chain (cod. 069) - fixed to the **CF 7 Wash Zoom** and to the primary suspension point, is highly recommended to protect against accidental failure, however unlikely, of the primary suspension point.

If using an after-market safety chain not manufactured by **coemar**, ensure that it is of sufficient rating to hold the weight of the fixture.

risk of fire

Each fixture produces heat and must be installed in a well-ventilated position. The minimum recommended distance from flammable material is: 0.5m. Minimum distance from the object being illuminated is: 2 m.

7. Mains connection

cabling

The mains cable provided is thermally resistant, complying to the most recent international standards. It meets or exceeds the VDE and IEC norms, IEC 331, IEC 332 3C, CEI 20 35.

NB: In case of cable replacement, similar cable with comparable thermal resistant qualities must be used exclusively (cable 3x1.5 ø external 10 mm, rated 300/500V, tested to 2KV, operating temperature -40° +180°, **coemar** cod. CV5309).

mains connection

CF 7 Wash Zoom can operate at voltages from 208V-230V-240V at 50 or 60Hz (operating voltage and frequency can be selected as described in section 5 of this manual).

Prior to connecting the unit to your mains supply, ensure that the model in your possession correctly matches the mains supply available to you.

For connection purposes, ensure your plug is of a suitable rating: 8 amps.

Locate the mains cable which exits the base of the unit and connect as shown below:

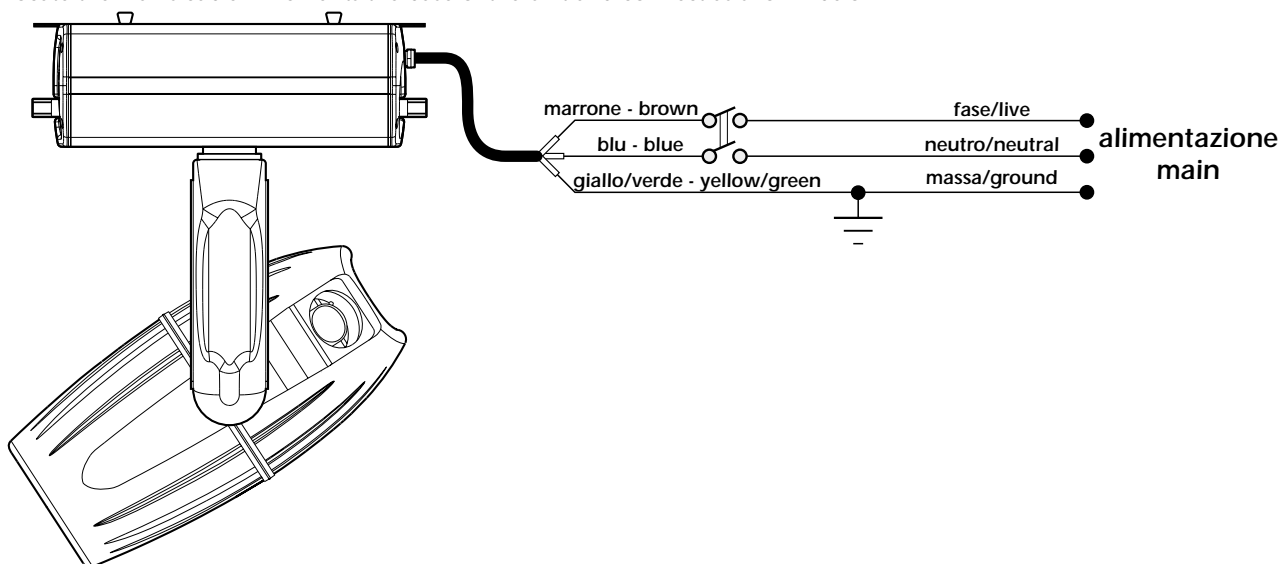

protection

The use of a thermal magnetic circuit breaker is recommended for each **CF 7 Wash Zoom**.

A good earth connection is essential for the correct operation of the fixture. Strict adherence to regulatory norms is strongly recommended.

Warning



WARNING!, DANGER!



The electronic ballast with which the **CF 7 Wash Zoom** is equipped, in common with other electronic devices such as amplifiers, monitors, and TVs, requires attention to the dimensions of the neutral cable, since the total current in the neutral cable is equal to the sum of all the current in all the active phases of the cable.

For example, if the current is measured at the distribution point as being 5Amps on phase R, 5Amps on phase S, and 5Amps on phase T, there will be a total of 15 Amps in the neutral.

We ask that you carefully consider your cable current loading and therefore ensure that your neutral cable is of a suitable rating.

CF 7 Wash Zoom a good earth connection; never install a fixture unless the yellow/green earth cable is properly connected.

ballast with PFC (power factor correction)

PFC is available as an accessory via the **coemar** distribution network.

8. Signal connection

Control signal is digital, and is transmitted via two pair screened $\varnothing 0.5\text{mm}$ cable. Connection is serial, utilising XLR 3 or XLR5 male and female sockets located on the base of the **CF 7 Wash Zoom**, labeled **DMX 512** and **DMX 512 standard** (see diagram).

Pin connections conform to the international standard:

- | | |
|-------------------------|----------------------|
| pin 1= screening 0 volt | pin 4= not connected |
| pin 2= data - | pin 5= not connected |
| pin 3= data + | |

8.1 signal connection using an XLR 5 plug/socket

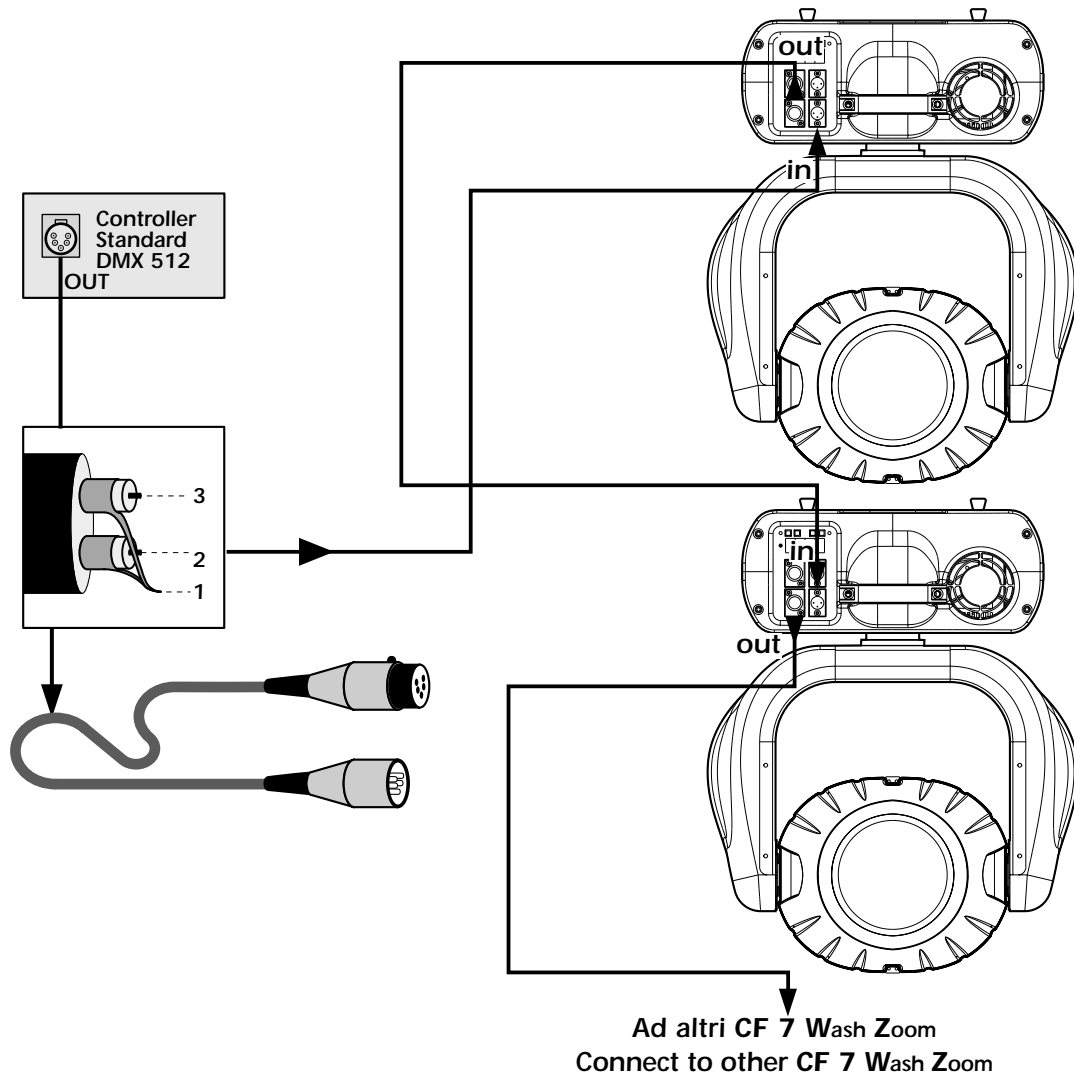

8.2. signal connection using an XLR 3 plug/socket

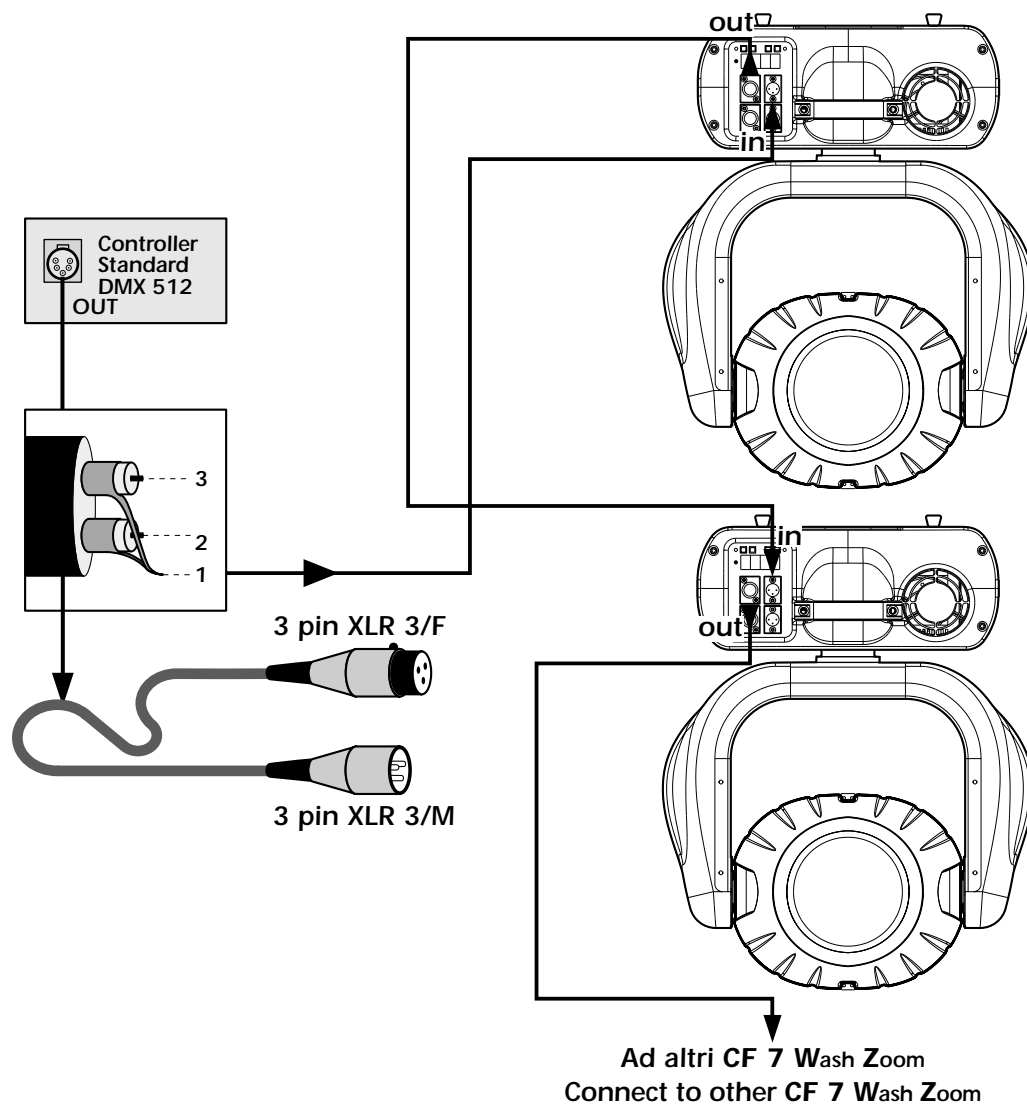

Ensure that all data conductors are isolated from one another and the metal housing of the connector.

Note: the housing of the cannon XLR 3 or 5 must be isolated.

9. Powering up

After having followed the preceding steps, turn on the DMX 512 controller which will be used to control the **CF 7 Wash Zoom**. Following this, turn on the power to the projector, and turn on the projector's power switch. The projector will perform a reset function on all the internal and external motors. This will last some few seconds, after which it will be subject to the external signal from the controller.

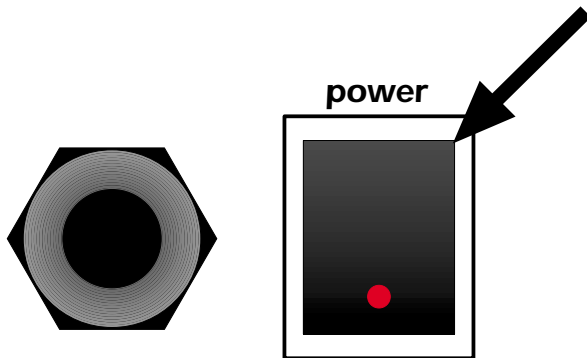

DMX led

The **DMX led** will be static on to indicate that **DMX 512** signal is being correctly received by the projector.

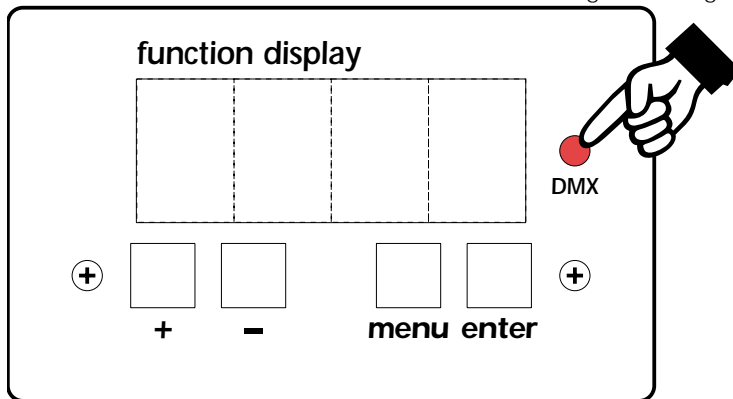

If the led is off, the projector is not receiving signal. check the cabling and the functioning of the controller.

10. DMX addressing

Each **CF 7 Wash Zoom** utilises **13 channels** of DMX 512 signal for complete control.

To ensure that each projector accesses the correct signal, it is necessary to correctly address each fixture. Any number between 1 and 495 can be generated via the multifunction panel of the **CF 7 Wash Zoom**.

This procedure must be carried out on every **CF 7 Wash Zoom** being used.

When powered up initially, each projector will show **A001** which indicates **DMX address 1**; a projector thus addressed will respond to commands on channels **1** to **13** from the **DMX 512** controller. A second projector should be addressed as **14**, a third as **27** and so on until the final **CF 7 Wash Zoom** has been addressed.

altering dmx addresses

- 1) Press the + or - button until the display shows the **DMX** required, the characters in the display panel will flash to indicate that the selection is not stored in memory.

function display

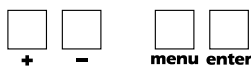
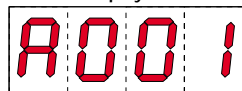

- 2) Press the enter button to confirm your selection; the display will stop flashing and the projector will now respond to the new DMX address.
- 3) To better understand the function of each channel, we refer you to section 12 "**Control channel functions from a DMX 512 controller**".























































































































Important Note: Keeping the + or - button pressed will cause the display to alter at increased speed, allowing a faster selection to be effected.

By pressing the - button, you may inadvertently select a DMX address which is not being communicated to the fixture by the controller, for example 500. If this is the case, the display will slow the data reception, (since it does not exist), and you will note that it is slow to respond to your commands (for example altering an address or requesting or confirming a reset). You may solve this problem by either sending data to this address, or by altering the incorrect DMX setting of the **CF 7 Wash Zoom**.

11. Display panel functions

By selectively using the functions provided in the **CF 7 Wash Zoom** which are accessible via the display panel, you are able to alter the operation of the unit by altering the various parameters. Making changes to the factory presets can result in the projector not responding to the controller's DMX 512 signals, therefore ensure that you read the following instructions carefully prior to making any changes to the fixture's parameters.

NOTE: the  symbol is used in the following instructions to indicate the action of pressing the button referred to in descriptions.

A001  menu	 +  0 - DIRP pan movement inversion To reverse horizontal movement direction of the beam from left to right and vice versa on DMX level variation.	 enter	 +  0 - CW clockwise	 enter
			 +  0 - CCW counter-clockwise	 enter
	 +  0 - DIRT tilt movement inversion To reverse vertical movement direction of the beam from the bottom upwards and vice versa, on DMX level variation.	 enter	 +  0 - CW clockwise	 enter
			 +  0 - CCW counter-clockwise	 enter
	 +  0 - OPTO optic sensors deactivation To deactivate optic sensors that sense the position of the yoke and the base of the unit and that allow the return in position of the unit if accidentally knocked out of place.	 enter	 +  0 - ON sensors activation	 enter
			 +  0 - OFF sensors deactivation	 enter
	 +  0 - PAN pan (base) movement amplitude To select pan movement amplitude between 630° and 385°.	 enter	 +  0 - 630 standard movement amplitude	 enter
			 +  0 - 385 385° movement amplitude	 enter
	 +  0 - LAMP lamp control Lamp on/off control inhibition by DMX signal.	 enter	 +  0 - STRD ignition by DMX 512	 enter
			 +  0 - ON lamp always on	 enter
	 +  0 - FANS fans control Fans function controlled through PCB (Strd) Fans always on (on).	 enter	 +  0 - STRD automatic on/off	 enter
			 +  0 - ON fans always on	 enter
	 +  0 - COLR colour wheel To center the colours of colour wheel on optical axis of the unit; to use proportionally the colour wheel through DMX 512.	 enter	 +  0 - STRD colours automatic centering	 enter
			 +  0 - SPEC proportional functioning	 enter
	 +  0 - DISP reverse display Reverse reading display depending on mounting position (ground mounted or suspended)	 enter	 +  0 - AA suspended position	 enter
			 +  0 - VV reverse	 enter
	 +  0 - LED display control To disable display visualisation	 enter	 +  0 - OFF switching off display ( any key to re-activate it)	 enter
	 +  0 - TEST display control Device operation test without using DMX signal	 enter	 +  0 - PAN pan movement test	 enter
			 +  0 - ALL motors test	 enter
	 +  0 - RESE reset Reset function	 enter	 +  0 - --- reset activation	 enter
	 +  0 - RATE DMX speed DMX signal reception speed	 enter	 +  0 - 24.S0 numeric value	 enter
	 +  0 - HOUR working time (lamp on) Visualisation of unit's working time (lamp on) (reset operation not possible)	 enter	 +  0 - 0550 numeric value shown in hours	 enter
	 +  0 - LIFE lamp life Visualisation of lamp life (time covered by mains supply from last reset operation)	 enter	 +  0 - 0280 numeric value shown in hours	 enter
	 +  0 - HTOT total working time Total visualisation of unit's working time (time covered by mains supply) (reset operation not possible)	 enter	 +  0 - 0600 numeric value shown in hours	 enter

11.1. Powering up the CF 7 Wash Zoom without articulated movement

This function may be useful should you need to power up the CF 7 Wash Zoom. This function may be useful should you need to power up the CF 7 Hard Edge to readdress it or alter any parameters and you wish to do this in the absence of any articulated movement.

- 1) Turn on the projector whilst holding down both the **enter** button and the **-** button.

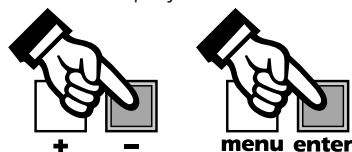

The projector will proceed with a reset of all the motors with the exception of those which control articulated movement, the pan and tilt motors, which remain static until a full reset is performed.

- 2) you may alter the DMX address, or any other parameters available via the menu system without any articulated movement occurring.
- 3) To return to normal functioning the projector needs simply be turned off and then turned on once again.

11.2. Counter reset

The lamp life counter needs to be reset to zero at every lamp change to provide accurate information on lamp life

- 1) Turn off the projector
- 2) Power up the CF 7 Wash Zoom whilst simultaneously holding down the **+** and **-** buttons.

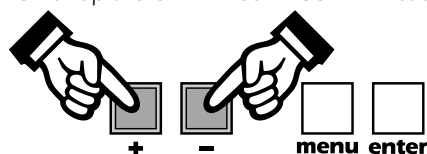

- 3) Press the **menu** button.
- 4) Press the **+** or **-** button until the display shows **LIFE** (for lamp life).
- 5) Press the **enter** button to confirm your selection; the display will show **0000** confirming that the counter has been reset.

11.3. test

This function allows for a test sequence to be carried out on the respective motors of the unit in the absence of any DMX signal.

- 1) Press the **menu** button.
- 2) Press the **+** or **-** button until the display shows **TEST** (for test).
- 3) Press the **enter** button to confirm your selection; the display will show **PAN** (for pan movement test., Press the **+** or **-** buttons for subsequent tests from **PAN** to **ALL**.

In these tests the projector simulates the reception of a DMX 512 signal which is increasing from 1 to 255 on the selected channel.

- 4) Press the **enter** button to confirm your selection of the test to be carried out.

PAN= movement in the X-axis

FPA= fine movement in the X-axis

TILT= movement in the Y-axis

FTI= fine movement in the Y-axis

DIMM= opening/closing of the dimmer

SHUT= opening/closing of the black-out / strobe

ZOOM= movement of the zoom system

RCOL= movement of the colour wheel

EFF= effects selection

CYAN= cyan

MAGE= magenta

YELL= yellow

ALL= testing all motors

NOFU= no function

12. DMX 512 signal functions

If all procedures have been correctly carried out to this point, the 13 channels of your DMX 512 controller will have full control over all the effects available from your **CF 7 Wash Zoom** as described in the following table:

channel	function	type of control	effect	decimal
1	Base (pan) coarse	proportional	coarse control of the base movement	0-255
2	Base (pan) fine	proportional	fine control of the base movement	0-255
3	Yoke (tilt) coarse	proportional	coarse control of the Yoke movement	0-255
4	Yoke (tilt) fine	proportional	fine control of the Yoke movement	0-255
5	dimmer	step	closed	0-7
		proportional	from close to open	8-255
6	shutter	step	closed	0-9
		proportional	strobe effect increasing flash rate	10-127
		proportional	random strobe, increasing flash rate	128-247
		step	open	248-255
7	Beam size	step	white clear	0-9
		proportional	from spot to Flood	10-255
8	filter selection	proportional	white clear	0-15
		proportional	filter 1 vertical alteration of adjustable beam angle	16-217
		proportional	filter 3 adjustable	218-255
9	color wheel	step	WHITE	0-24
		step	color 1	25-49
		step	color 2	50-73
		step	color 3	74-99
		step	color 4	100-123
		step	color 5	124-151
		proportional	continuous color wheel rotation clockwise with proportional speed from min. to max.	152-255
NOTE: channel 9 function can be varied selecting color standard/special function on the back function display				
9	color wheel	step	white clear	0-9
		proportional	proportional 360° color wheel rotation .	10-151
		proportional	continuous color wheel rotation clockwise with proportional speed from min. to max.	152-255
10	cyan	step	white clear	0-9
		proportional	proportional cyan control from white to cyan	10-255
11	magenta	step	white clear	0-9
		proportional	proportional magenta control from white to magenta	10-255
12	Yellow	step	white clear	0-9
		proportional	proportional yellow control from white to yellow	10-255
13	Lamp ON, motor Reset, pan/tilt speed control mode	step	lamp off	0-9
		step	park, no function	10-28
		step	pan/tilt go to sensor (only once)	29-100
		step	all motor reset (only once)	101-170
		step	lamp on (pan/tilt soft movement)	171-240
		step	lamp on (pan/tilt standard movement)	241-255
Display panel can modify function channel (inhibit lamp off)				
note 1: 2 or 4 numbers close to the end limit levels cannot be used as unstable levels				
note 2: function channel has a delay time of 6 second to prevent accidental activation.				
note 3 :on/off lamp mode is not affected unless an opposite value is received				
Fixture type: coemar CF 7 wash zoom			Chart name: DMX 512	
Chart number: 188		Release: 3	Date: 17/11/2000	

13. Aligning the lamp in the optical system

Aligning the lamp in the optical system is achieved via the 3 adjusters at the rear of the projector. This procedure should be undertaken to properly align the lamp in the optical system and to avoid the possible overheating of the internal components due to the incorrect focusing of the beam onto components not intended to be exposed to this.

alignment procedure

Alignment is effected via the 3 adjusters **A**, **B** and **C** operating in conjunction with each other. The lamp should be on, black-out and dimmer fully open, and no colour filters inserted.

If the lamp is not correctly aligned, a hot-spot will be noticeable. This is a function of the lamp's positioning. Use the two adjusters (**A** and **B**) to bring the hot-spot to the centre of the beam. Use the third adjuster (**C**) to flatten the beam to maximum uniformity.

vertical adjustment

Adjuster (**B**) acts on a lever and spring assembly to position the lamp via a vertical movement within the reflector; rotate it until correct positioning is achieved.

horizontal adjustment

Adjuster (**A**) acts on a lever and spring assembly to position the lamp via a horizontal movement within the reflector; rotate it until correct positioning is achieved.

axial adjustment

Adjuster (**C**) moves the entire lamp assembly axially within the unit; rotate it until correct positioning is achieved, resulting in a flat, even beam.

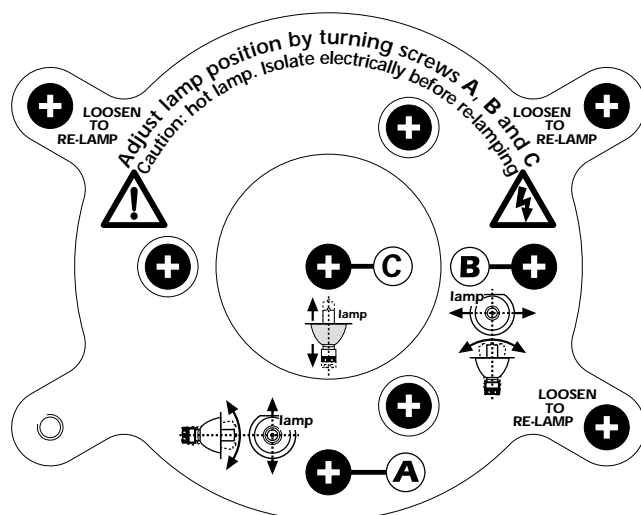

14. Opening up the projector housing

By removing the carbon fibre casing, complete access is available to the internals of the projector.

Attention

Remove mains power prior to accessing the internal components of the projector.

- 1) Lift the 2 latches located towards the rear of the unit and the two towards the front.



- 2) Detach the safety cables.

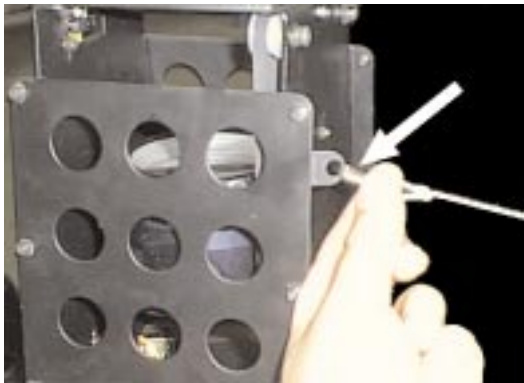

15. Interchanging dichroic filters

The dichroic filters on the projector's colour wheel may be replaced as required; replacement dichroics must measure \varnothing 45mm, with a thickness of 1 mm and should be manufactured of tempax glass (high-temperature resistant). Prior to any internal procedures being undertaken on the projector, you are reminded to disconnect the mains power.

Attention

Remove mains power prior to accessing the internal components of the projector.

replacing a dichroic filter

Open up the projector housing as described in the previous section entitled: *Opening up the projector housing*

- 3) Locate the dichroic colour wheel
- 4) Manually rotate the colour wheel to find the dichroic filter you wish to replace.
- 5) Remove the dichroic filter by first pressing down and then sliding the filter out towards the outside of the colour wheel.



- 7) Reverse the procedure to install the new filter.

Attention: the side of the filter which has been dichroically treated should be faced towards the lamp

- 8) Close and fasten the housing of the **CF 7 Wash Zoom**.

16. Automatic internal functions

CF 7 Wash Zoom has several automatic functions and features which at first glance may not be noticed. However, they serve to add functionality to the projector, and to assist in extending the serviceability of the unit.

on-board hot-strike timer

This on-board feature ensures that the operator cannot re-ignite the lamp until 6 minutes have passed since the lamp was switched off.

This is designed to avoid damage to the lamp ignition circuit which can occur if an operator continually attempts to strike a hot lamp. It further protects the lamp from possible damage due to voltage spikes which may occur at this time.

NOTE: The timer is reset only when the projector is switched off.

on-board lamp ignition timer

This feature ensures that an operator cannot repeatedly attempt to strike a lamp for more than 3 seconds if the lamp does not ignite. It will automatically attempt to restrike the lamp for 3 seconds in every subsequent minute.

This is designed to protect the ballast and lamp ignitor from prolonged usage in less than ideal conditions.

NOTE: it is important to replace a lamp that is at the end of its useful life and replace it. Old lamps are generally progressively more difficult to strike.

thermal protection

Two thermal sensors in the body and base of the **CF 7 Wash Zoom** protect the unit against overheating.

The thermal sensors operate by removing voltage to the lamp if the ambient temperature rises above a preset maximum due to either less than ideal air circulation around the fixture or in the event of cooling fan failure.

automatic realignment

An internal 4 point encoder system allows the **CF 7 Wash Zoom** to return to its correct position in case the unit is accidentally knocked out of alignment whilst operating. This is particularly useful if the projector is to be mounted on the floor in a position where the performer or artist may accidentally bump the unit.

NOTE: this facility may be deactivated if desired (see section 11 opto).

17. Maintenance

Whilst every possible precaution has been taken to ensure the trouble-free operation of your **CF 7 Wash Zoom**, the following periodic maintenance is highly recommended.

Attention

Disconnect mains power prior to removing the projector housing.

To gain access to the internals of the unit refer to the previous section of this manual, *Opening up the projector housing*.

periodic cleaning lenses and reflectors

Even a fine layer of dust can reduce the luminous output substantially. Regularly clean all lenses and the reflector using a soft cotton cloth, dampened with a specialist lens cleaning solution.

fans and air passages

The fans and air passages must be cleaned approximately every 6 weeks; the period for this periodic cleaning will depend, of course, upon the conditions in which the projector is operating. Suitable instruments for performing this type of maintenance are a brush and a common vacuum cleaner or an air compressor.

periodic maintenance lamp

The lamp should be replaced if there is any observable damage or deformation due to heat. This will avoid the danger of the lamp exploding.

mechanicals

Periodically check all mechanical devices for wear and tear; gears, guides, belts, etc., replacing them if necessary. Periodically check the lubrication of all components, particularly the parts subject to high temperatures. If necessary, lubricate with suitable lubricant, available from your coemar distributor.

electrical components

Check all electrical components for correct earthing and proper attachment of all connectors, refastening if necessary.

fuse replacement

Locate the fuse, which protects the lamp and electronics, in the base of the **CF 7 Wash Zoom**. Using a multimeter, test the condition of the fuse, replacing it with one of equivalent type if necessary.

18. Electronic motor alignment

INSTALLER INSTRUCTIONS ONLY

The display panel at the rear of the **CF 7 Wash Zoom** allows for the electronic alignment of the projector's motors. This procedure is performed by **coemar** at the factory. It may be useful to perform this procedure in the case of internal components being replaced.

Altering the factory settings may radically alter the functioning of the projector. Carefully read all of the following prior to attempting any changes.

electronic calibration

Important Note: electronic calibration is only possible if the projector is connected to a **DMX 512** source.

- 1) Press the menu button.
- 2) Press the + or - button until the display shows **RESE** (for reset).
- 3) Press the enter button to confirm your selection then immediately and simultaneously press and hold the **menu button**, holding both pressed for at least **30** seconds. The motors of the unit will perform a reset and the display will show **---** for some few seconds, indicating that you have entered the electronic calibration mode.

+0-	PNAL pan alignment Pan movement alignment	enter	0128	+0-	es.	0120	enter
+0-	TLAL tilt alignment Tilt movement alignment	enter	0128	+0-	es.	0120	enter
+0-	SHAL shutter alignment Shutter alignment	enter	0128	+0-	es.	0120	enter
+0-	CYAL cyan alignment Cyan colour alignment	enter	0128	+0-	es.	0140	enter
+0-	MAAL magenta alignment Magenta colour alignment	enter	0128	+0-	es.	0130	enter
+0-	YEAL yellow alignment Yellow colour alignment	enter	0128	+0-	es.	0125	enter
+0-	FIAL filter alignment filter alignment	enter	0128	+0-	es.	0135	enter
+0-	COAL colour wheel alignment Alignment of colour wheel	enter	0128	+0-	es.	0132	enter
+0-	DIAL dimmer alignment Alignment of dimmer	enter	0128	+0-	es.	0127	enter
+0-	END end To end the motors' electronic alignment procedure and confirm it.	enter	A001				

Note: Simultaneously pressing the + and - buttons will return the calibration value to the default value of 128.

19. Spare parts

All the components of the **CF 7 Wash Zoom** are available as replacement spares from your authorised **coemar** sales agent.

Accurate description of the fixture, model number, and type will assist us in providing for your requirements in an efficient and effective manner.



coemar spa

via Inghilterra
46042 Castelfredro (Mantova) Italy
Tel. 0376/77521
Fax 0376/780657

coemar si riserva il diritto di apportare modifiche senza preavviso.
coemar reserves the right to effect modifications without notification

manuale istruzioni
instruction manual

CF 7 Wash Zoom

1[^] edizione novembre 2000
1st edition november 2000